



**2009-C Ram 1500 Classic**  
**2019-C Ram 2500/3500** (Old Body and New Body)  
**No-Drill Front Rubber Mud Flap Set**  
**Mounting Diagram & Instructions**  
**Kit's # RCR31F / RCR32F**

**IMPORTANT:**

**Manufacturer is not responsible for negligent use of vehicle with mud flaps installed, including over-tightening of screws and bolts causing damage to vehicle or mud flaps.**



**TOOLS REQUIRED**

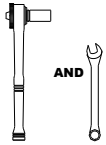

5/16 & 3/8" Open End Wrench & Socket Wrench

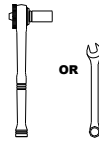

10mm open end or Socket Wrench

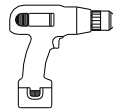

Electric or Chargeable 1/2" or 3/8" Drill



3/8" Socket Driver



1/4" Drill Bit

**FLAPS**

(1) Flap Assembly, Front, DS

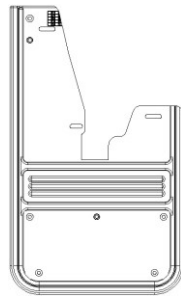

(1) Flap Assembly, Front, PS

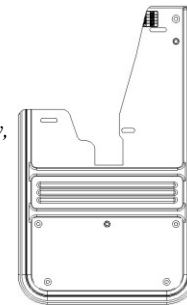

**PARTS BAG # 766126**

**a)** (8) Washer, Flat 0.203" x 1", SS Part #018081



**b)** (2) Washer, Lock #10, Helicoil, SS Part #024001



**c)** (2) Hex Nut #10, SS Part #025003



**d)** (2) Mach. Screw #10-24 x 1", SS Part #012022



**INSTALLATION**

1. Before you install your Gatorback Mud Flap, see the diagram and parts list for all necessary parts.
2. Remove two (2) factory screws #4 & #5. Using the two (2) factory screws and included washers, reinstall on holes #1 & #2. Loosely secure at this point.
3. Square the flap with the tire, while putting pressure against the wheel well, then tighten the two (2) factory screws #4 & #5.
4. Hold flap tight against wheel well and drill 1/4" hole (1), from the center of the slotted hole #3 through the factory plastic liner. Secure the flap with one (1) machine screw #012022, two (2) flat washers #018031, one (1) lock washer #024001 and one (1) hex nut #025003.
5. Repeat procedure for passenger side.

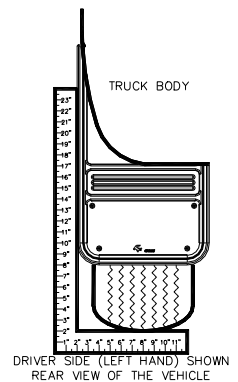

REMOVE THE FACTORY SCREWS AND REINSTALL THROUGH HOLES #1 AND #2

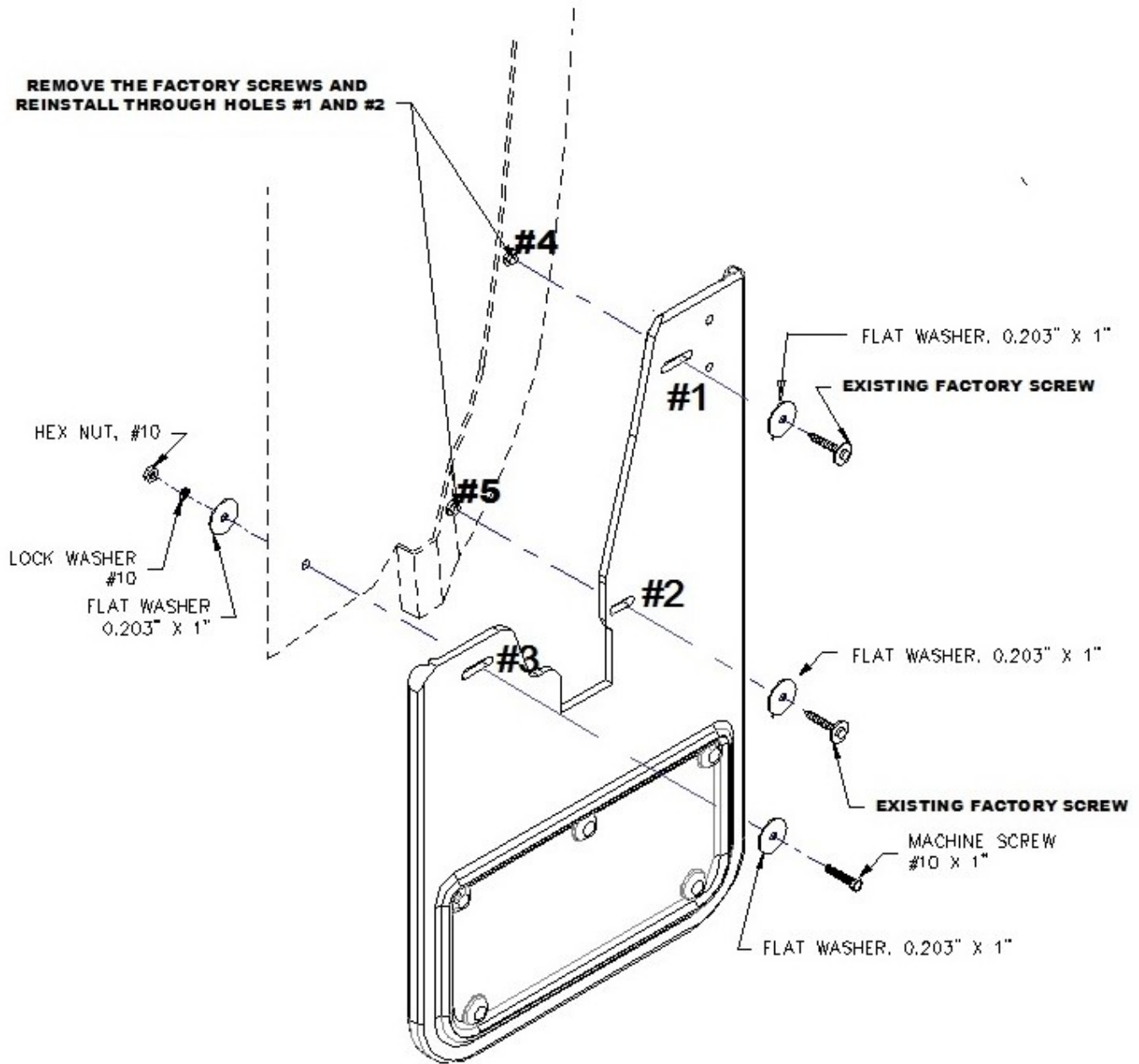

Please check out our YouTube channel to see an install video for this application.



1520 - 33 St N · Lethbridge, AB T1H 5H3 · Canada  
Toll free: 1-800-661-8208 · Email: info@truckhardware.ca · www.truckhardware.ca





**2009-C Ram 1500 Classic  
2010-2018 Ram 2500 / 3500  
No-Drill Rear Rubber Mud Flap Set  
Mounting Diagram & Instructions  
Kit # RCR33R**

**IMPORTANT:**

**Manufacturer is not responsible for negligent use of vehicle with mud flaps installed, including over-tightening of screws and bolts causing damage to vehicle or mud flaps.**

**NO-DRILL SYSTEM**

**TOOLS REQUIRED**

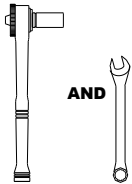

5/16 & 3/8" Open End Wrench & Socket Wrench

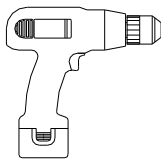

Electric or Chargeable 1/2" or 3/8" Drill



3/8" Socket Driver

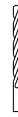

1/4" Drill Bit

**FLAPS**

(1) Flap Assembly, Front, DS

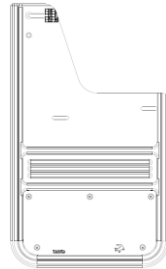

(1) Flap Assembly, Front, PS

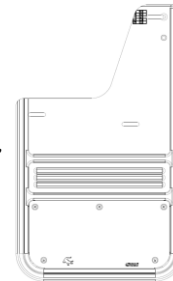

**PARTS BAG # 766127**

a) (6) Washer, Flat 0.203" x 1", SS Part #018081



b) (2) Washer, Lock #10, Helicoil, SS Part #024001



c) (2) Hex Nut #10, SS Part #025003



d) (2) Screw, Machine #10 x 1.5" Part #012027

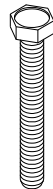

e) (2) Washer, Half, SS 0.203" x 1" Part #018032

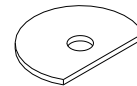

**INSTALLATION**

- Before you install your Gatorback Mud Flap, see the diagram and parts list for all necessary parts.
- Remove two (2) factory screws #4 & #5. Using the two (2) factory screws and included washers #018081, reinstall on holes #1 & #2. Loosely secure at this point.
- Square the flap with the tire, while putting pressure against the wheel well, then tighten the two (2) factory screws #4 & #5.
- Hold flap tight against wheel well and drill a 1/4" hole (1), from the center of the slotted hole #3 through the factory plastic liner. Secure the flap with one (1) machine screw #012027, one (1) flat washer #018081, one (1) half washer #018032, one (1) lock washer #024001 and one (1) hex nut #025003.
- Repeat procedure for passenger side.

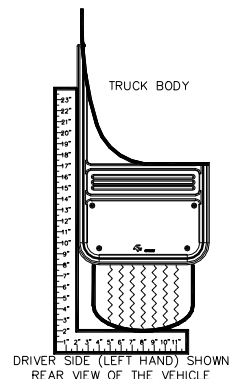

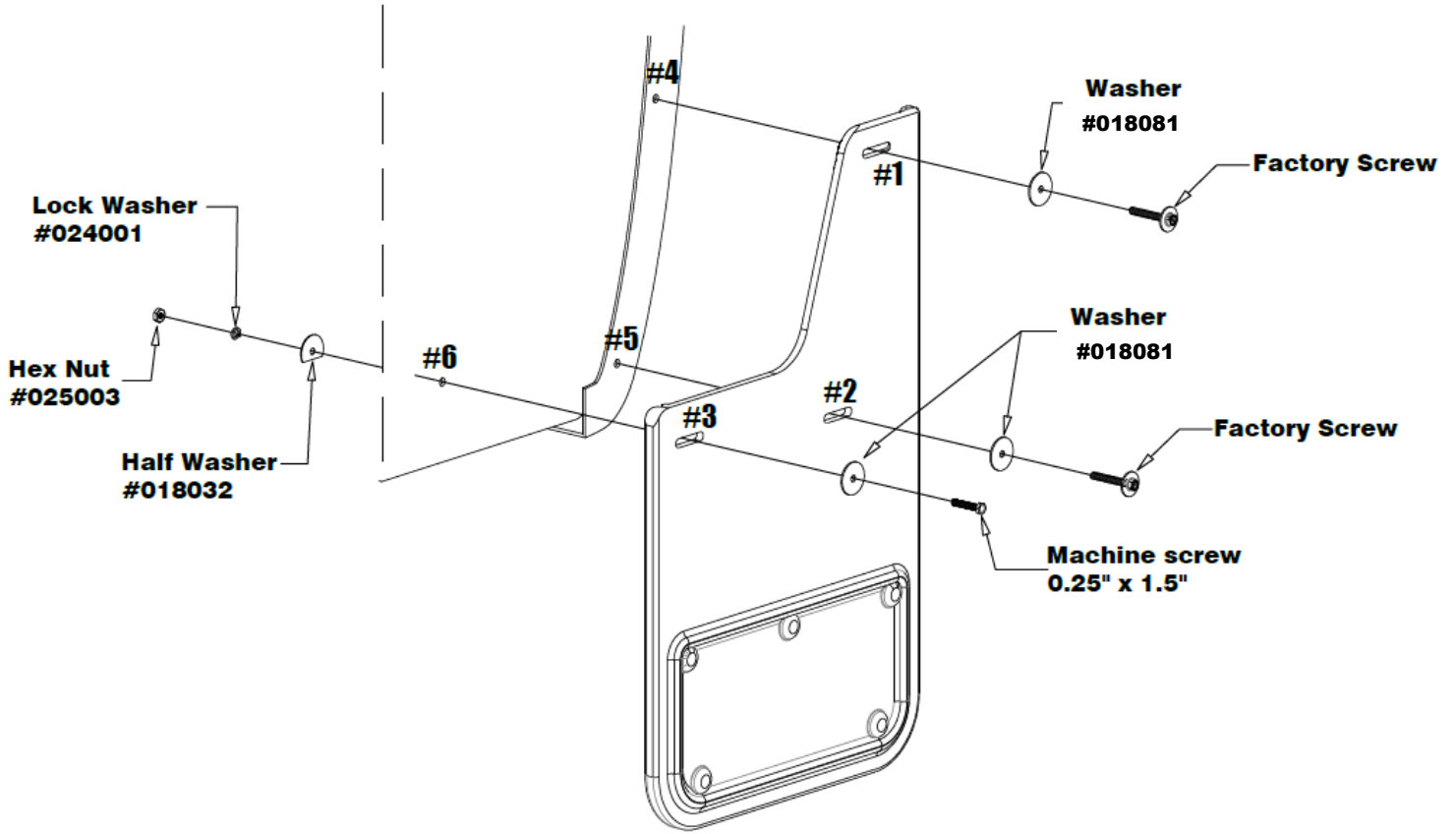

Please check out our YouTube channel to see an install video for this application.

