



**21-C Jeep Grand Cherokee  
Mud Flap Set, Front  
Mounting Diagram & Instructions  
Kit# GCR62F  
Will not fit Summit Reserve Model**

**IMPORTANT:**

**Manufacturer is not responsible for negligent use of vehicle with mud flaps installed, including over-tightening of screws and bolts causing damage to vehicle or mud flaps.**



**TOOLS REQUIRED-**

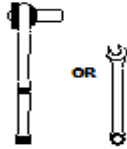

5/16" Open Wrench or  
Socket Wrench

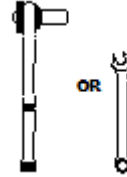

7/16" Open Wrench or  
Socket Wrench

**FLAPS**

(1) Flap Assembly,  
Front, DS

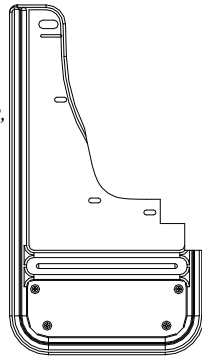

(1) Flap Assembly  
Front, PS

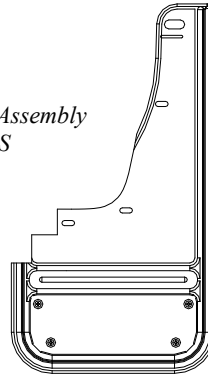

**PARTS BAG # 770525**

**a) (2) Capscrew, SS**  
1/4"-20 x 5/8" Blk Ox.  
Part # 014071



**b) (6) Screw, Sheet Metal**  
#8-18 x 1.5" Blk Oxid.  
Part #016063



**c) (2) Washer, Flat**  
0.203" x 1" 18g. SS, Blk Oxid.  
Part #018070

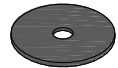

**d) (4) Washer, Flat**  
0.203" x 1.5" SS, Blk Ox.  
Part #018080



**e) (2) Washer, Flat**  
0.281" x 1", SS Blk Oxid.  
Part #018084



**f) (1) Mount Clip, DS**  
w/Clinch Nut  
Part #769308

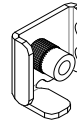

**g) (1) Mount Clip, PS**  
w/Clinch Nut  
Part #769309

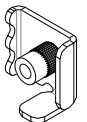

**INSTALLATION** (For ease of installation it is suggested that the wheel be removed)

1. Before you install your Mud Flap Set, see the diagram and parts list for all necessary parts. Start on the driver's side.
2. Remove 3 factory screws from fender
3. Install mount clip (f) on mud flap hole #1 using a capscrew (a) and flat washer (e)
4. Loosely secure mud flap hole #2 to factory hole #5 using a sheet metal screw (b) and flat washer (d)

5. Slide mount clip behind fender lip to secure
6. Loosely secure mud flap hole #3 to factory hole #6 using a sheet metal screw (b) and flat washer (d)
7. Loosely secure mud flap hole #4 to factory hole #7 using a sheet metal screw (b) and flat washer (c)
8. Square the flap using a square or other levelling tool.
9. Tighten all fasteners.
10. Repeat procedure for passenger side.

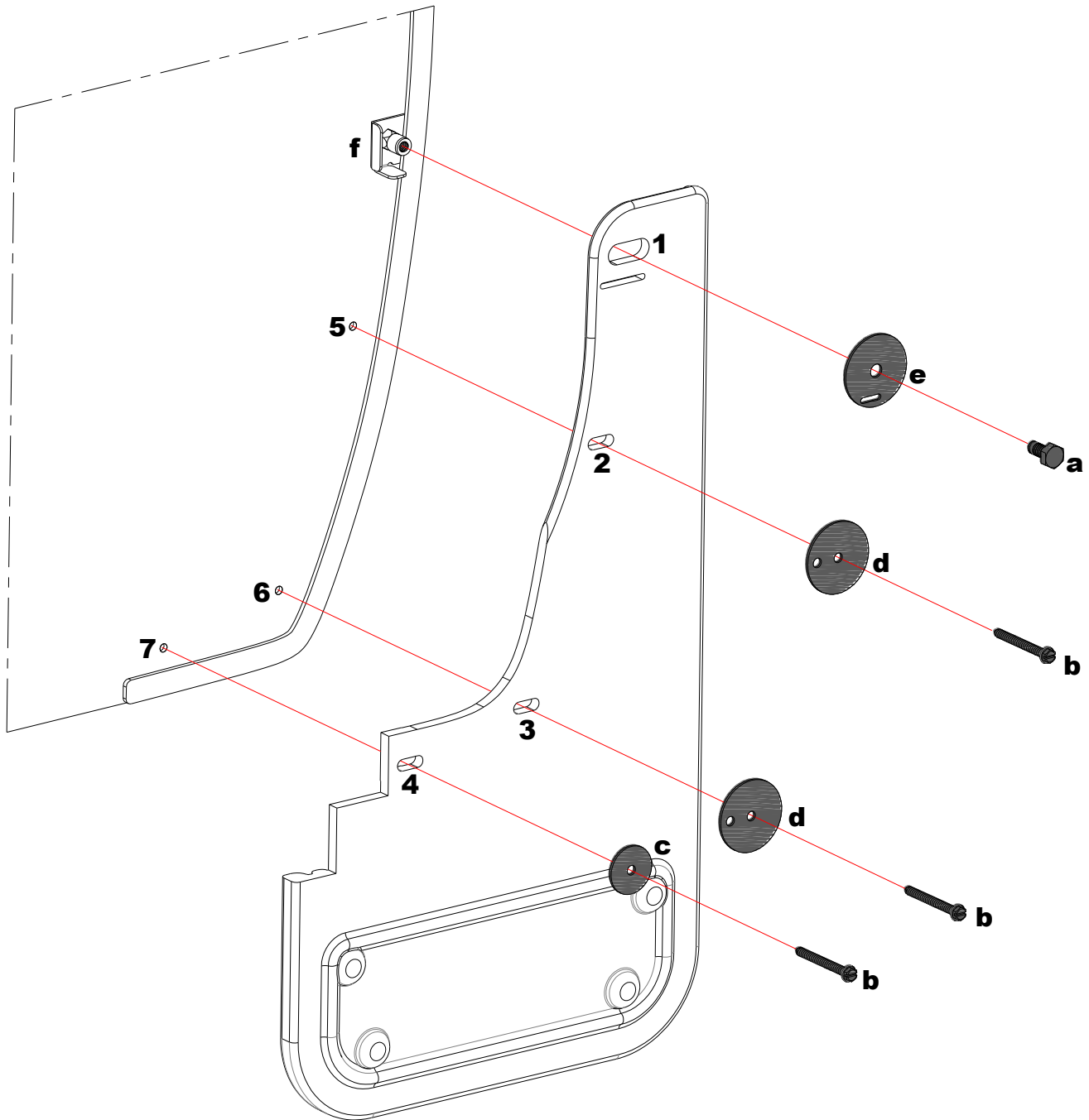

Please check out our YouTube channel to see an install video for this application.





**21-C Jeep Grand Cherokee  
Mud Flap Set, Rear  
Mounting Diagram & Instructions  
Kit# GCR62R  
Will not fit Summit Reserve Model**

**IMPORTANT:**

**Manufacturer is not responsible for negligent use of vehicle with mud flaps installed, including over-tightening of screws and bolts causing damage to vehicle or mud flaps.**



**TOOLS REQUIRED-**

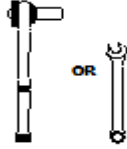

5/16" Open Wrench or  
Socket Wrench

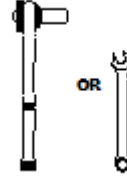

7/16" Open Wrench or  
Socket Wrench

**FLAPS**

(1) Flap Assembly,  
Front, DS

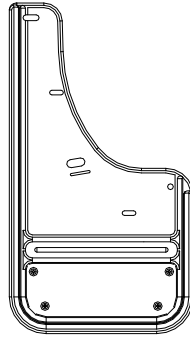

(1) Flap Assembly  
Front, PS

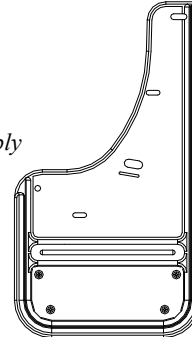

**PARTS BAG # 770526**

**a)** (2) Screw, Mach.  
#10-24 x 1", SS  
Part #012022

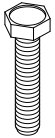

**b)** (2) Capscrew, SS  
1/4"-20 x 3/8" Blk Ox  
Part # 014069



**c)** (2) Capscrew, SS  
1/4"-20 x 5/8" Blk Ox  
Part #014071

**d)** (4) Screw, Sheet Meta  
#8-18 x 1.5" Blk Oxid.  
Part #016063



**e)** (4) Washer, Flat  
0.203" x 1" SS  
Part #018081

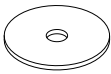

**f)** (2) Washer, Flat  
0.281" x 1" 18g. Blk Oxid.  
Part #018069

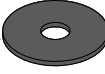

**g)** (2) Washer, Flat  
0.203" x 1" Blk Oxid.  
Part #018070

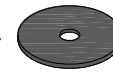

**h)** (2) Washer, Flat  
0.281" x 1.5", SS Blk Oxid  
Part #018084

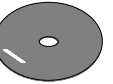

**i)** (4) Washer, Flat  
0.203" x 1.5" Blk Ox.  
Part #018080



**j)** (2) Washer, Lock  
#10, Stainless  
Part #024001



**k)** (2) Hex Nut  
#10-24, Stainless  
Part #025003



**l)** (2) Spring Nut  
1/4"-20, 0.54" Reach  
Part #028010



**m)** (2) Spacer, Nylon  
1/2" OD x 0.257" ID x 0.5"  
Part #054063



**n)** (2) Spacer Washer  
7/16" x 1" x 1/4"  
Part #054091



**p)** (1) Mount Clip, DS  
w/Clinch Nut.  
Part #769308

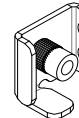

**q)** (1) Mount Clip, PS  
w/Clinch Nut  
Part #769309

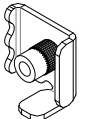

**INSTALLATION** (For ease of installation it is suggested that the wheel be removed)

2. Before you install your Mud Flap Set, see the diagram and parts list for all necessary parts. Start on the driver's side.
2. Remove 2 factory screws from fender

3. Install mount clip (n) on mud flap hole #3 using a capscrew (b) and flat washer (h)
4. Loosely install mud flap hole #2 through a spacer (m) and flat washer (e) to factory hole #6 using a sheet metal screw (d), and flat washer (i)
5. Slide mud flap clip behind fender.
6. Align mud flap with fender and mark fender through mud flap hole #1.
7. Install spring nut (l) on fender where it was marked in step 6.
8. Loosely install mud flap hole #1 to spring nut (l) using a cap screw (b) and flat washer (f).
9. Loosely install mud flap hole #4 through spacer washer (n) to factory hole #7 using a sheet metal screw (d), and flat washer (i).
10. Square the flap using a square or other levelling tool.
11. Drill 1/4" hole through mud flap hole #5 into factory liner, and install mud flap to newly drilled hole #8 using a machine screw (a) and flat washer (g) and secure using a flat washer (e), lock washer (j) and hex nut (k)
12. Tighten all fasteners.
13. Repeat procedure for passenger side.

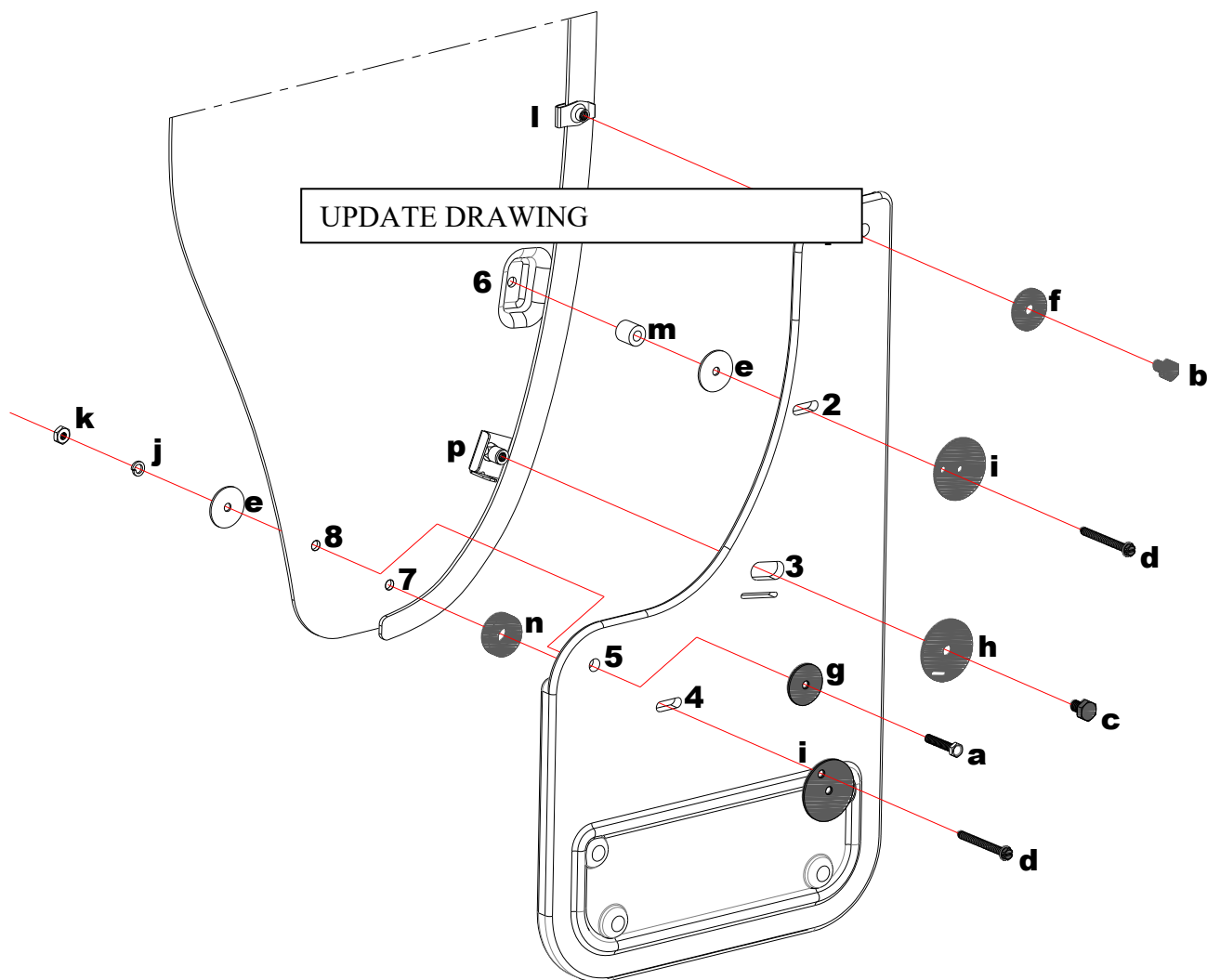

Please check out our YouTube channel to see an install video for this application.

